

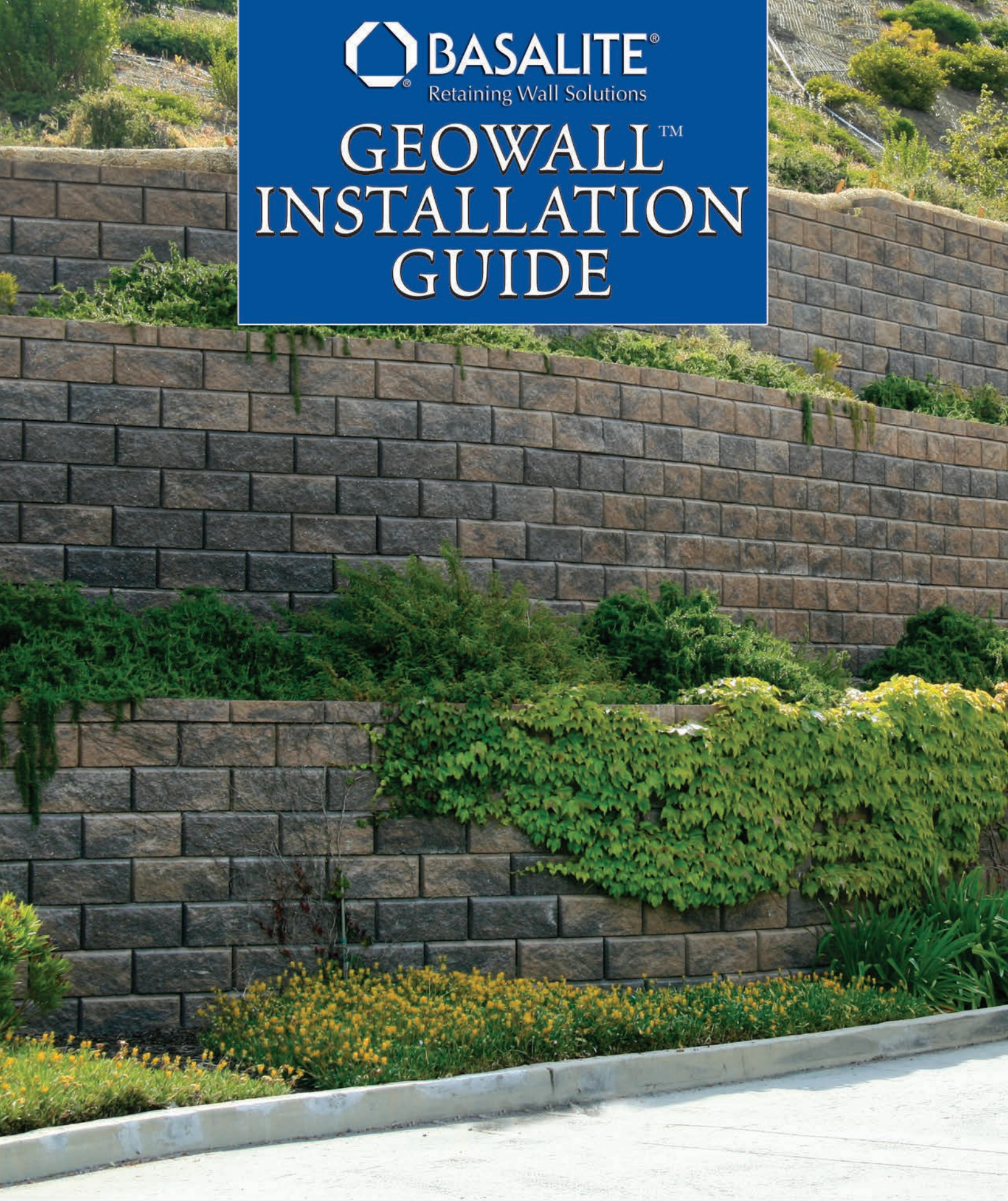

GEO WALL™ INSTALLATION GUIDE







BASALITE RETAINING WALL SYSTEMS

Basalite® Concrete Products, LLC is a leading manufacturer of concrete hardscape products, including pavers, retaining walls, concrete masonry units, dry mix and related accessories.

With over 50 years of manufacturing excellence,

Basalite has earned a reputation for high quality products, experienced personnel and unrelenting customer service.

Basalite is pleased to offer this guide to installing segmental retaining wall systems. The information contained within was compiled from a number of sources, including the National Concrete Masonry Association (NCMA), proprietary product procedures, and from our own experience working with architects, engineers and contractors.

For the most current information including complete installation, estimating tools and product details, please visit us on line at: www.basalite.com.

DISCLAIMER

The material contained in this guide does not cover all possible situations, but is intended to represent some of the more widely-used SRW installation practices and other related information. Site specific conditions should be evaluated by a qualified engineer to prepare the plans and specifications appropriate for each particular project. Care has been taken to ensure the information included in this guide is as accurate as possible, however, Basalite Concrete Products LLC does not assume responsibility for errors or omissions resulting from the use of this guide. Additionally, information contained herein and in subsequent specific product modules may not conform to local building code requirements, and should be reviewed carefully to assure compliance.

CONTENTS

1.0 Introduction

1.1 Welcome	01
1.2 System Components	02
1.3 Tools & Equipment	03
1.4 Starting Your Project	04
1.5 Technical Support	05

2.0 Retaining Wall Principals

2.1 Wall Types	06
----------------	----

3.0 Retaining Wall Installation

3.1 Installation	07
3.2 Geogrid Reinforcement	09

4.0 Installation Details

4.1 Stepping the Base Course	10
4.2 Terraced Walls	11
4.3 Fence Posts	11
4.4 Caps	12
4.5 Drain Pipes	13
4.6 Water Applications	13
4.7 Curves-Convex with Geogrid	14
4.8 90 Degree Corner with Geogrid	14

5.0 Installation Tables

5.1 Standardized Tables	15
-------------------------	----



1.1 WELCOME

Geowall is an excellent solution for a variety of wall applications, ranging from simple landscape projects to critical structures. Available in four face styles and attractive earth-tone colors, Geowall will meet your structural requirements while providing lasting beauty that will complement your design for years to come. Geowall can be constructed from 2 feet tall to heights limited only by the soils supporting the wall. If you want additional information, contact the Engineered Wall Professional at your local Basalite distributor, or visit our website at Basalite.com.

This manual includes Geowall Pro and Geowall Max product information, estimating and installation procedures. The Geowall Pro is an excellent choice for building Structural Soil Reinforced Retaining Walls. It is lighter in weight and has a tail design that makes lifting the block much easier. The Geowall Max is for taller gravity and reinforced wall structures. With a depth of 21.5 inches, the Geowall Max is more stable during construction, allowing for greater productivity. Geowall Max is a superb choice for a durable, structurally sound wall system for critical applications.

This manual is an overview of the design and construction methods - your site conditions may vary and the actual design should always be performed by a qualified professional engineer and checked by the local building department.

While this manual provides general guidelines, installation contractors should always refer to the construction drawings provided by a qualified professional engineer.

1.2 SYSTEM COMPONENTS

The Geowall Pro and Max structural retaining wall systems are high-performance systems which use two pultruded fiberglass pins for alignment and inter-unit connection. These block systems are typically used with Geogrid which, when engineered together, can create tall, stable, structural retaining walls. Geowall is excellent for landscaping, residential and commercial development, or where space is at a premium.

Geowall™ Pro

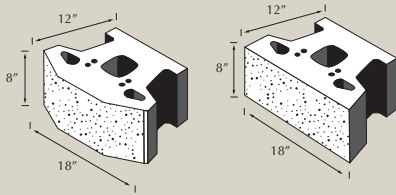

Tri-Plane Face
 Weight: 75 lbs
 Face area/unit: 1 sf
 Units/pallet: 45

Straight Face
 Weight: 81 lbs
 Face area/unit: 1 sf
 Units/pallet: 45
 *special order

Geowall™ Max

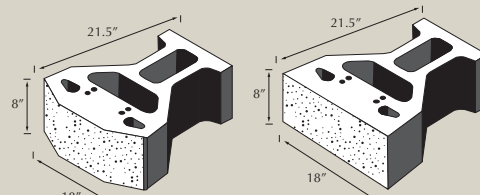

Tri-Plane Face
 Weight: 90 lbs
 Face area/unit: 1 sf
 Units/pallet: 30

Straight Face
 Weight: 103 lbs
 Face area/unit: 1 sf
 Units/pallet: 30
 *special order

Geowall™ Caps

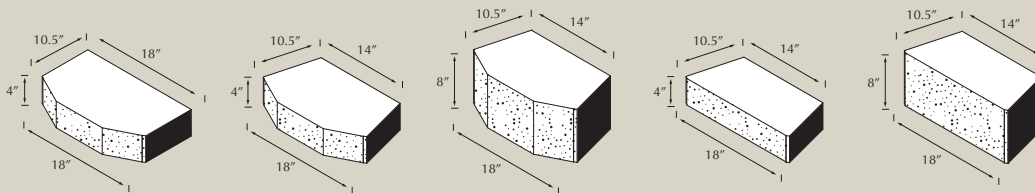

4" Straight Cap
 Weight: 31 lbs
 Face area/unit: 1/2 sf
 Units/pallet: 80

4" Tapered Cap
 Weight: 31 lbs
 Face area/unit: 1/2 sf
 Units/pallet: 80

8" Tapered Cap
 Weight: 65 lbs
 Face area/unit: 1 sf
 Units/pallet: 50

4" Tapered Cap
 Weight: 47 lbs
 Face area/unit: 1/2 sf
 Units/pallet: 80

***8" Tapered Cap**
 Weight: 95 lbs
 Face area/unit: 1 sf
 Units/pallet: 40

Positive Connection Systems

GEOWALL™ Pro and Max units use pultruded fiberglass pins for connection and alignment. The pins control the amount of setback in the wall and attach the geogrid to the blocks.

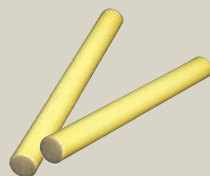

Dimensions: 5-1/4" x 1/2"
 Flexural Strength: Minimum 125,000 psi
 Short Beam Shear Strength: Minimum 6400 psi
 Reference Standards: ASTM D-4475, ASTM D-4476



1.3 TOOLS & EQUIPMENT

Planning and advance preparation are important to the success of your retaining wall project. Before you start your project, acquiring the proper tools is essential. Below is a guideline for the tools that will be needed to complete the installation of a segmental retaining wall.

Required Tools & Equipment:

- Hammer, Rubber Mallet and Sledge Hammer
- 4-foot Level
- 4-inch Chisel
- Torpedo Level
- Shovel
- Vibratory Plate Compactor
- Hand Tamper
- String Line
- Broom
- Measuring Tape
- Caulking Gun
- Layout/Survey Stakes
- Safety Protective Equipment; Ear Plugs, Dust Mask, Protective Boots, Gloves and Glasses/Goggles

Optional Tools & Equipment:

- Electric Circular Saw and Masonry Blade
- Respirator
- Hard Hat, Safety Vest
- Transit or Laser Level
- Backhoe Excavator, Mini Excavator or Skid Steer

Always wear the proper protective equipment and use all tools as prescribed by the manufacturer.

1.4 STARTING YOUR PROJECT

The Geowall Pro is palletized with 45 square feet per pallet, and the Geowall Max is palletized with 30 square feet per pallet. Minimum inside radius, measured at the base course to the front of the units, is 6 feet.

Minimum outside radius, measured at the base course to the top of the units, is 6 feet.

Contact the Engineered Products Sales Professional at your local Basalite dealer to calculate the number of pallets and caps you will need for your project, or visit our website at Basalite.com.

1. Initial Site Visit Checklist:

- Job Site Access
- Wall Location
- On-Site Soils
- Wall Length
- Wall Height
- Topography/Slope Angles
- Curves/Convex-Concave-Corners
- Steps
- Terraced Walls
- Caps
- Fencing
- Guard Rails
- Water
- Drainage and Drain Pipe
- What type of wall is required-Gravity or Soil Reinforced? Read page 6 for a description of these walls and check the standardized engineering on pages 15 and 16 for reference. If the wall exceeds the Gravity wall height, or you are unsure, contact a Qualified Professional Engineer or a Basalite Engineered Wall Specialist for assistance.

2. Read and understand this manual:

- Basic Installation
- Gravity and Soil Reinforced Retaining Wall
- Details
- Water and Drainage

3. Pre-Construction:

- Check staking for proper wall placement on the property or lot line. Be aware of setbacks/batter in the wall for finished top-of-wall location. Verify the wall location with the project superintendent or property owner.
- Understand your soils refer to the soils report and engineering to verify that the soils you are using during construction are the same soils the engineer used when designing the wall. Black-Peat Moss or Organics cannot be used as a backfill.
- Confirm the location of all underground utilities. Call Digline at 811, 1-800-342-1585 or visit www.digline.com.
- Verify that all necessary and proper building permits are obtained.
- Prepare an erosion and sediment control plan that meets the requirements of your local municipality. Check the weather forecast and plan construction during dry weather, if possible.
- Check that the block and cap are the correct color and quantity and that they match the Engineering and submittals.
- Check that the geogrid matches the engineering design parameters and submittals.
- Check that the on-site soils match the engineering design.
- Check that the delivered aggregates match the submittals.
- Check that the site conditions (slope, loads, etc) match the engineering design.
- Verify that all tools and equipment are on site and that they are in proper working condition.

**Becoming familiar with this manual by reading and understanding it is imperative.
Learning the details and terms will help ensure that your wall is correctly built and completed on schedule.**



1.5 TECHNICAL SUPPORT

Basalite looks at each project as individual and unique. We realize how important it is to provide you with technical assistance when needed. Our team of experts can help you with your project from the initial planning stages through final engineering and approval, but our experience does not stop there.

We can assist with submittals, details and drawings, and pre-construction meetings.

We offer the following services to the licensed design professional:

1. Design program for licensed engineers
2. Contractor Estimator Program
3. Design assistance
4. Details and diagrams
5. Specifications
6. Product submittals
7. Pre and Post Construction Meetings

2.1 WALL TYPES

Segmental Retaining Walls are classified in three ways: Conventional/Gravity Walls, Soil Reinforced Walls, and Specialty Walls.

Gravity Walls

A Conventional or Gravity Wall is a wall that does not require Geogrid soil reinforcement. This wall system relies on the mass weight of the block, batter or setback of the block, frictional connection between blocks, and proper soils to resist the earth's applied pressures. A primary advantage of a Gravity Wall is that a small work area is required behind the wall, eliminating over-excavating of the soils. The maximum gravity height of each retaining wall is unique to each block, the soils and loading conditions.

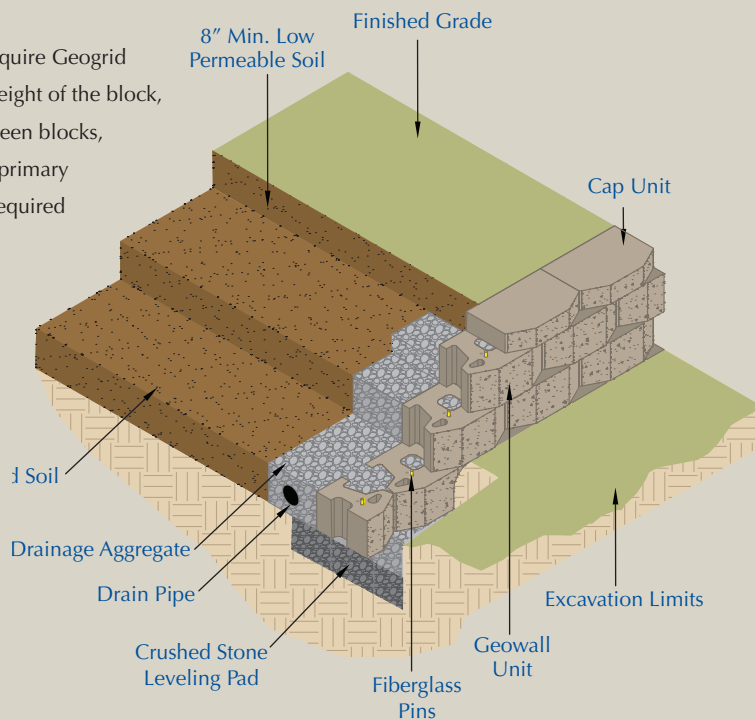

Soil Reinforced Walls

A Soil Reinforced or Mechanically Stabilized Earth (MSE) Wall is a durable and cost-efficient method of constructing taller walls. Soil Reinforced Walls, typically utilized on fill sites, require increased work area behind the wall, soils capable of proper utilization with reinforcement, and design by a qualified professional engineer.

A soil reinforced wall stabilizes the block face with the soil mass behind the block by utilizing layers of geosynthetic reinforcement. The layers connect to the block face and extend horizontally into the soil. The large stabilized soil mass is referred to as the reinforced soil zone. The greater the reinforced soil mass, the larger or taller the soil embankment that can be retained or held back.

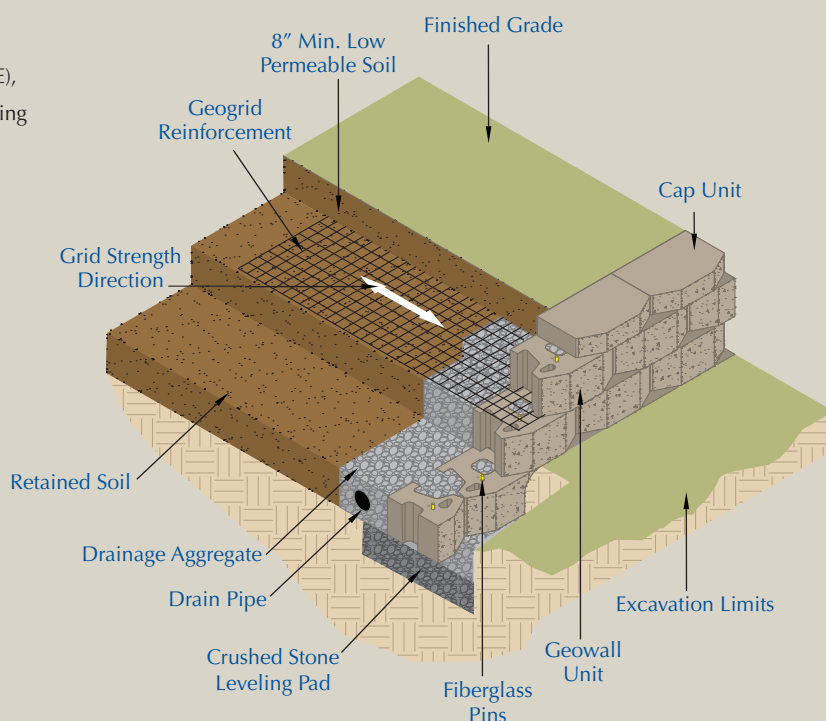

3.1 INSTALLATION

Successful installation begins with proper planning: the site soils, groundwater, horizontal and vertical layout, structural design, wall loadings, observation, testing and construction assurance are all vital to building a quality wall. If your wall is taller than four feet, or has a steep slope at the top of the wall, in front of the wall, or a load will be on top of the wall, (parking spot-driveway etc), consult an engineer before starting your project planning and construction.

1. Lay Out the Wall

Select the wall location and length for the retaining wall and using wooden stakes and a string line, plan out the wall. If necessary, have a qualified professional surveyor stake out the wall according to the lines and dimensions on the stamped engineering plans. Verify the proper locations with the project superintendent or homeowner.

2. Excavation

Verify that the layout dimensions are correct and excavate to the lines and grades as shown on the stamped and approved construction plans. Install erosion and sediment control measures according to plan. If possible, perform excavation during dry weather to reduce erosion and sediment issues. Remove all vegetation and organics, and other debris. Check that the foundation sub-grade is suitable. If any conditions exist that are unacceptable, do not proceed until they have been corrected. Proceed excavating the leveling pad to obtain proper block embedment. For small Geowall gravity walls, the minimum embedment is 6 inches. However, on geogrid Geowalls, the table shown below, from NCMA, will help determine the embedment depth. Prior to excavating or digging any trenches, call before you dig. Calling 811 is a free service that will notify all agencies to mark their underground utilities. Allow 48 hours prior to beginning construction. This will prevent any possible disruption

SLOPE IN FRONT OF WALL	MINIMUM EMBEDMENT
Minimum Requirement	0.5 ft (150 mm)
Horizontal Walls	H/20
Horizontal Abutments	H/10
3H:1V	H/10
2H:1V	H/7

in service to your neighbors, damage to your equipment, or possible serious injury or death to you, should you contact a high power line. Sloping Toe: the minimum embedment in front of the wall will increase when there is a slope in front of the wall. Most municipalities follow the California Building Codes, which establishes rules and regulations. The minimum horizontal bench in front of most walls is 4 feet, however, you should check with your local building department as regulations varies per municipalities.

3. Leveling Pad

Start the leveling pad at the lowest elevation along the wall and work upward, always maintaining a fully buried block. The leveling pad's minimum width is the unit width plus 12 inches; the minimum leveling pad's depth is 6 inches plus the height of the block. The leveling pad shall consist of 6 inches of a well-compacted (95% Standard Proctor) angular material (1/2 inch road base or 3/4 inch clean crushed angular rocks). The wall must step up in equal increments, always maintaining unit embedment, (see page 10, figure 4.1). Pea Gravel, sand or other material that is round or organic in nature is not acceptable for use in a leveling pad.

4. Base Course

Place the first course of Geowall units side by side, with each block touching the next; do not leave gaps or spaces. Each block should be leveled front to back and side to side. When consecutive blocks are laid, check the level of multiple blocks using a four-foot level. Ensure that the units are in full contact with the base. Place a string line at the back of the blocks to ensure your wall is straight and true to the intended lines. (see figure A)

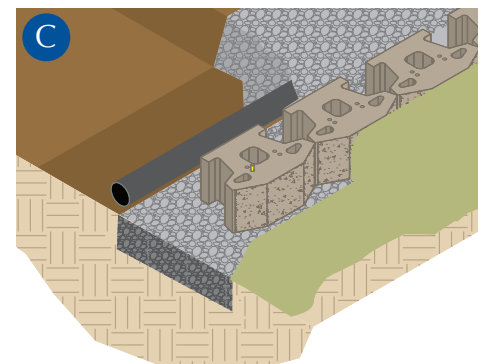
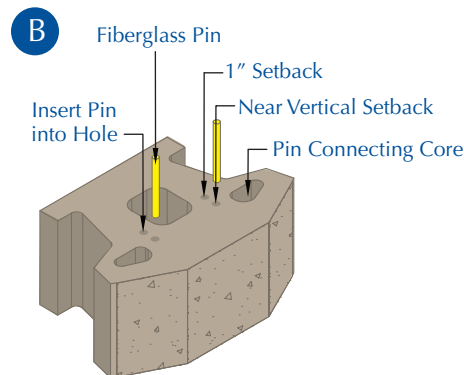
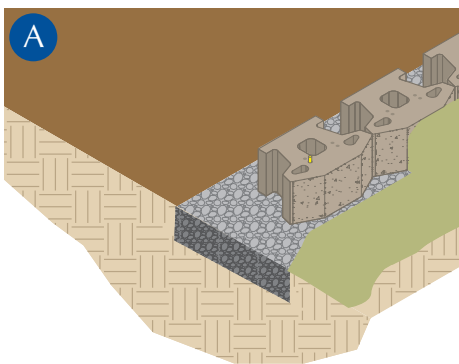

5. Pins

Geowall units have two setback options; front pin position (near vertical position), and the rear pin position (1 inch setback). Also available is an optional 1/2 inch position, which is a combination of alternating the front and rear position. (see figure B)

6. Drainage Pipe

Install a minimum 4-inch diameter perforated or slotted PVC pipe behind the blocks. Outlet the drain pipe to a storm drain, or daylight the pipe where the water will flow away from the wall face. On walls longer than 100 feet (see page 13 - 4.5 Drain Pipes) you will need to daylight the drain pipe through the front face of the wall every (50) fifty feet and at each end connecting to a storm drain, so that the water drains away from the wall. (see figure C)

7. Backfill and Compaction

After installing the pins and the drain pipe, place 3/4-inch clean crushed angular rock 24 inches behind the face of the block, filling all voids and cavities in the Geowall block and covering the drain pipe. Place the wall backfill material behind the drainage rock in maximum of 8-inch lifts or to a height that your vibratory equipment is capable of compacting. Compact the soils to 95% Standard Proctor Density using the appropriate compaction equipment. When compacting within (3) three feet of the back of the wall, use only hand operated equipment.

8. Installing Additional Courses

Prior to laying the next course, sweep the bottom course free of rock or other debris. Place the block so that the unit is centered above where the two bottom units meet. This is called a "Running Bond" pattern. Place the block so that the pins fit into the pin receiving holes, pulling the units toward the front of the wall. Once placed, check the blocks to ensure that they are level and in the correct batter. Periodically you may need to "shim" the blocks. Use the correct materials including but are not limited to asphalt roofing material, geogrid, or polyester rope. After the next course has been placed, continue with placing the pins in the pin receiving holes and with backfilling the blocks, placing 3/4-inch clean crushed angular rock from the face of the block, back

24 inches. Place the structural backfill material in lifts no greater than 8 inches, or according to the capabilities of your equipment. When you have completed backfilling and compacting, sweep the blocks and start your next course, or if you have reached your desired height, follow the "Capping the Wall" steps. (see figure D)

9. Installing Geogrid

Geosynthetic reinforcement is required for taller walls or walls constructed in poor soils, or where the wall is supporting critical structures. Prior to installing geogrid, you should consult a qualified professional engineer and obtain the approved set of construction plans. The first step when installing geogrid is to install the pins and sweep the blocks of any debris. Measure and cut the geogrid according to the approved plans then install the geogrid reinforcement, ensuring that the strength direction is laid perpendicular to the wall. Stack the next course of blocks to secure the geogrid reinforcement in place, then pull the geogrid reinforcement taut eliminating any wrinkles or slack. After the geogrid and block course have been placed, continue with placing the pins in the pin receiving holes. Then backfilling the blocks, place 3/4-inch clean crushed angular rock from the face of the block back 24 inches, then place the structural backfill material. (see page 9, 3.2 Geogrid Reinforcement). (see figure E)

10. Capping the Wall

When the design heights are achieved, start to cap the wall with the appropriate Geowall capping unit. Start by first sweeping the retaining wall blocks so they are free of rocks and debris. Place the caps from the lowest point and work toward the top. Use a masonry concrete adhesive to secure the caps in place. The caps can be installed with an overhang, also known as a shadow effect, or they can be placed flush with the retaining wall block. (see figure F)

11. Final Grade

The final grading or planting can now be put in place. This final lift is typically an 8-inch layer of low permeability soil. This is to help prevent water from penetrating into the reinforced soil zone and creating potential problems. Do not make any changes to this area without the approval of the design engineer.

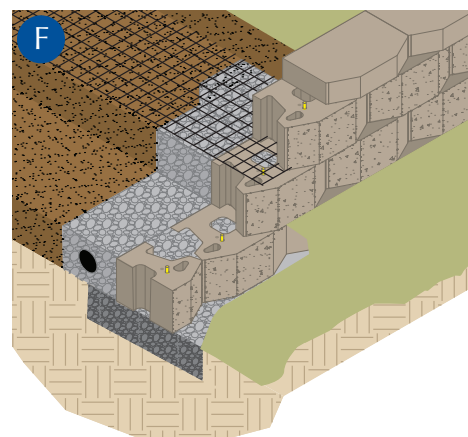
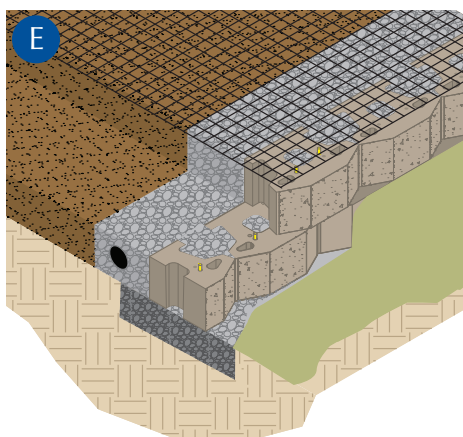
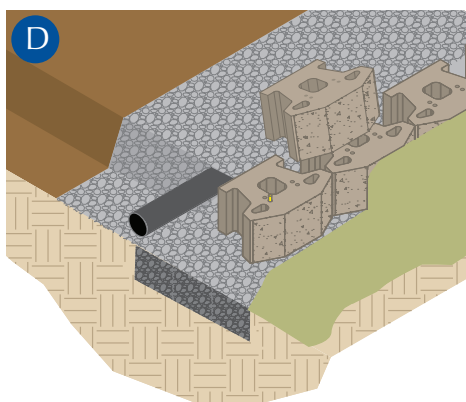

3.2 GEOGRID REINFORCEMENT

Geogrid reinforcement is required in walls taller than the block's structural gravity capabilities. When geogrid reinforcement is required in a retaining wall, a qualified professional engineer must be consulted to design the wall.

The final, approved design must be followed exactly by the installation contractor, and any changes to the installation must be reviewed by the engineer prior to commencing.

1. Make sure you have a set of plans that are approved for construction. Review the plans for completeness, asking the design engineer for clarification of any issues.
2. Evaluate the placement of each layer of geogrid, checking the lengths and strengths.
3. Cut the geogrid to the length noted on the plans.
4. Understand how geogrid works - there is a specified strength direction that must be followed. On most geogrids, the strength direction is perpendicular to the wall.
5. Sweep the top of the blocks of any debris. Set the geogrid 1 inch from the face of the block, placing it over the alignment pins. Do not overlap the geogrid courses.
6. Install the next course of blocks, pulling them forward and away from the reinforced soil zone.
7. Pull the geogrid taut toward the back of the reinforced soil zone, securing it down with stakes, staples or U-nails.
8. After you have installed the pins, add the 3/4-inch clean crushed angular rock 24 inches behind the face of the block, filling all voids and cavities in the GeoWall unit.
9. Add the backfill material to the end of the reinforced soils zone. To ensure proper compaction, Basalite recommends that you have your compacted soils tested by a qualified licensed professional geotechnical engineer.
10. Keep heavy equipment 3 feet away from the back of the block. Do not drive on the geogrid until a minimum of 6 inches of material has been placed on top of the reinforcement. Avoid sudden braking and sharp turns with equipment while driving on the geogrid as it can damage or move the geogrid.

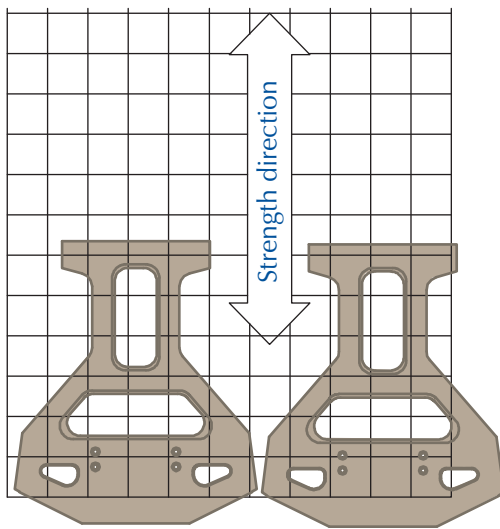

Geogrid is to be placed on level backfill over the fiberglass pins. Place next unit. Pull grid taut and backfill. Stake as required.

4.1 STEPPING THE BASE COURSE

Geowall retaining wall blocks must be constructed level, both horizontally and vertically. Courses should not be sloped to match the slope of the existing ground. When walls are constructed on sloping land, the base course must be stepped up in 8-inch increments as often as necessary.

Starting at the lowest point of the wall, dig out the leveling pad until the pad is 14 inches below the ground level and 12 inches wider than the block. By doing this, you will have enough room for the leveling pad material and to bury one full block.

Start laying the base blocks, working from the lowest point in the wall toward the step-up point. Once the step-up point has been reached, step up the next section of the trench 8 inches, keeping the course level from this point.

Continue to step up as needed to the top of the slope, maintaining at least one buried course.

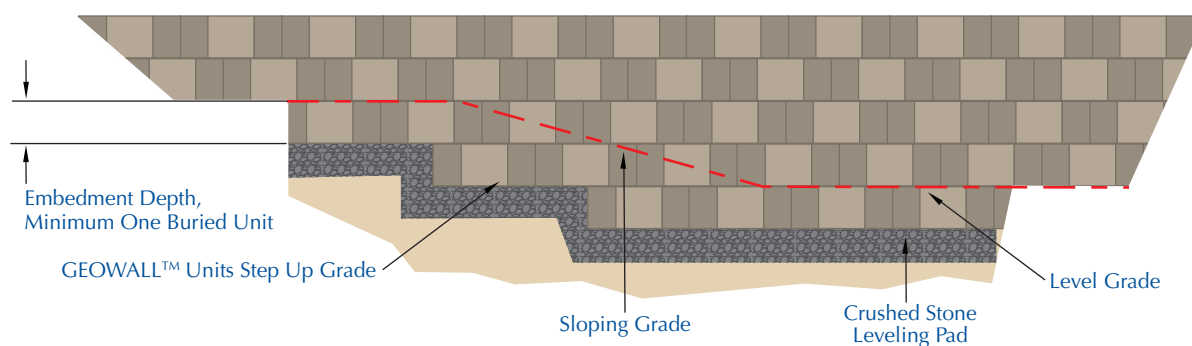

4.2 TERRACED WALLS

There are two types of terraced retaining walls:

1. Independent Terraced Walls

An Independent Terraced Wall is a wall in which the upper wall does not apply a surcharge or load on the lower wall. The upper wall must maintain a 2:1 ratio away from the lower wall, or the upper wall must be built twice the height of the lower wall away from the lower wall to meet this criteria. Therefore, if the lower wall is 3 feet tall, then the upper wall must be built 6 feet away. The upper wall must also be equal to or less, than the height of the lower wall. For proper drainage, it is important that the upper wall's drain pipe does not outlet onto the lower wall.

2. Dependent Terraced Walls

A Dependant Terraced Wall is a wall in which the upper wall places a surcharge on the lower wall. When the distance between the upper wall and the lower wall is closer than twice the height of the lower wall, the walls are dependent on each other. In this situation, it is important to seek out the help of a qualified professional engineer, so that a detailed engineering analysis, including a Global Stability Analysis, can be performed.

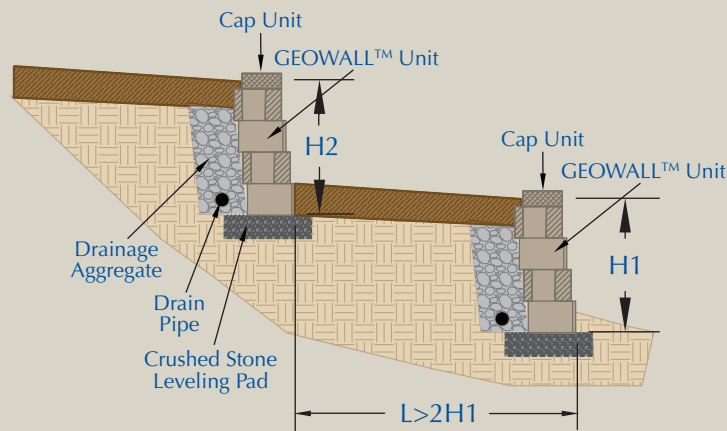

4.3 FENCE POSTS

NOTE:

1. Auger through Geogrid Layers
2. Backfill or Concrete Guardrail/ Fence Post in Place

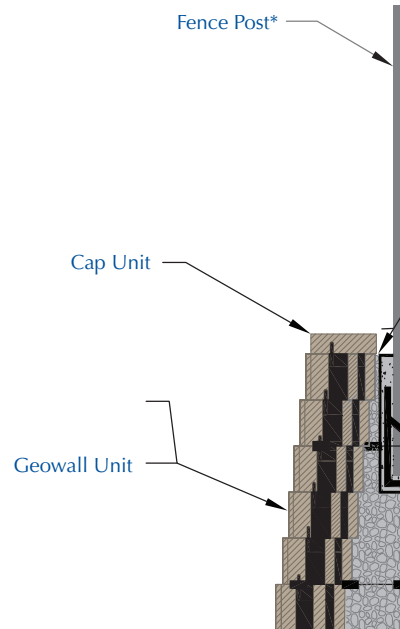
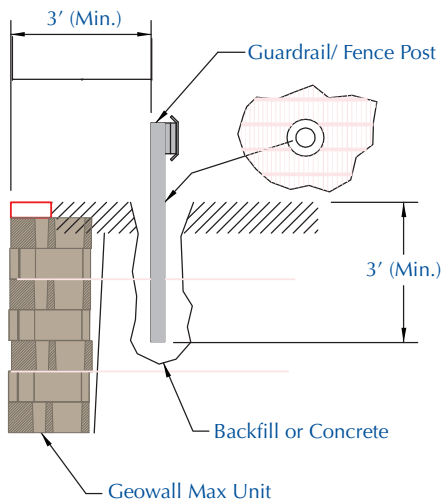

*Fencing systems approved for use with Sleeve-It™ 1224R are listed below:
 • Chain Link - Up to 8 feet
 • Privacy - Up to 6 feet
 • Post Size 4" x 4" Max

4.4 CAPS

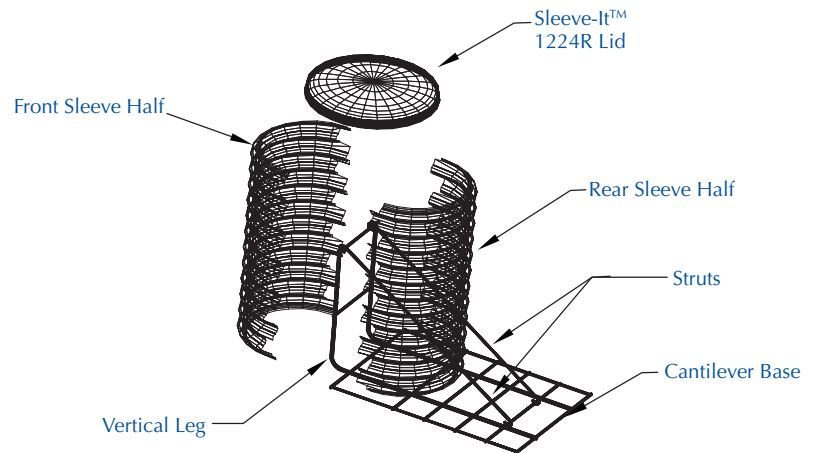
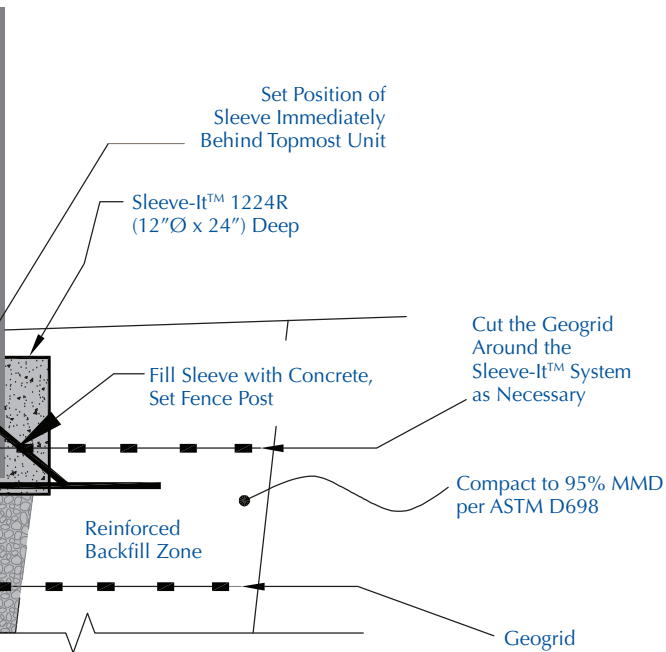
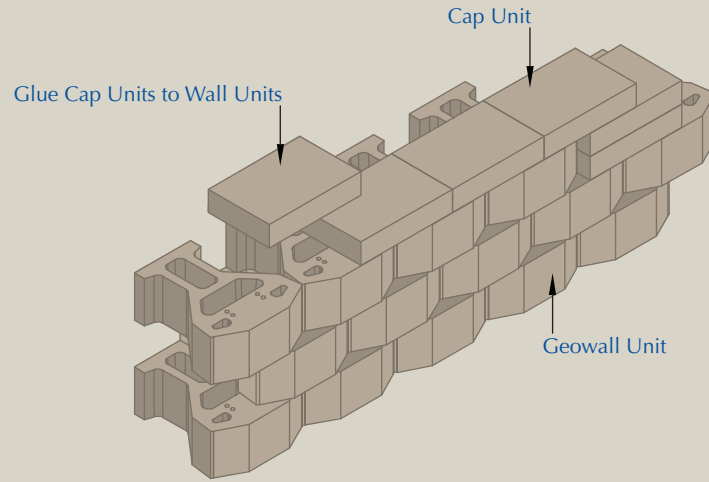

...ved for use with the
 ...mited to the following heights:
 ...feet
 ... (Wooden, PVC, Metal)
 ...imum

4.5 DRAIN PIPES

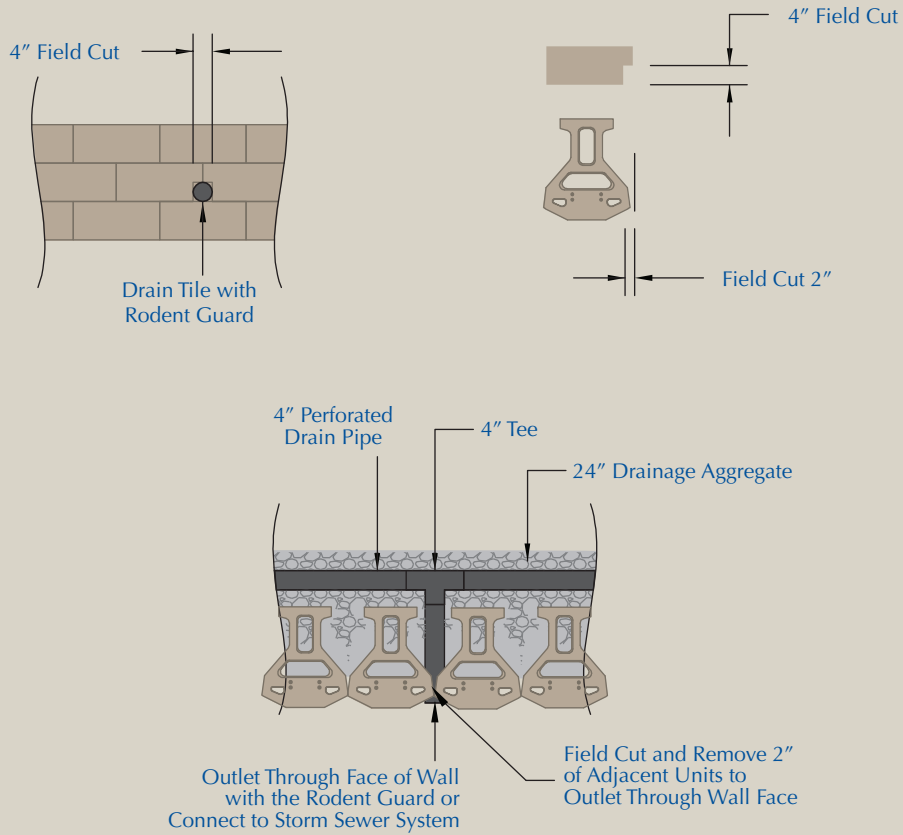

4.6 WATER APPLICATIONS

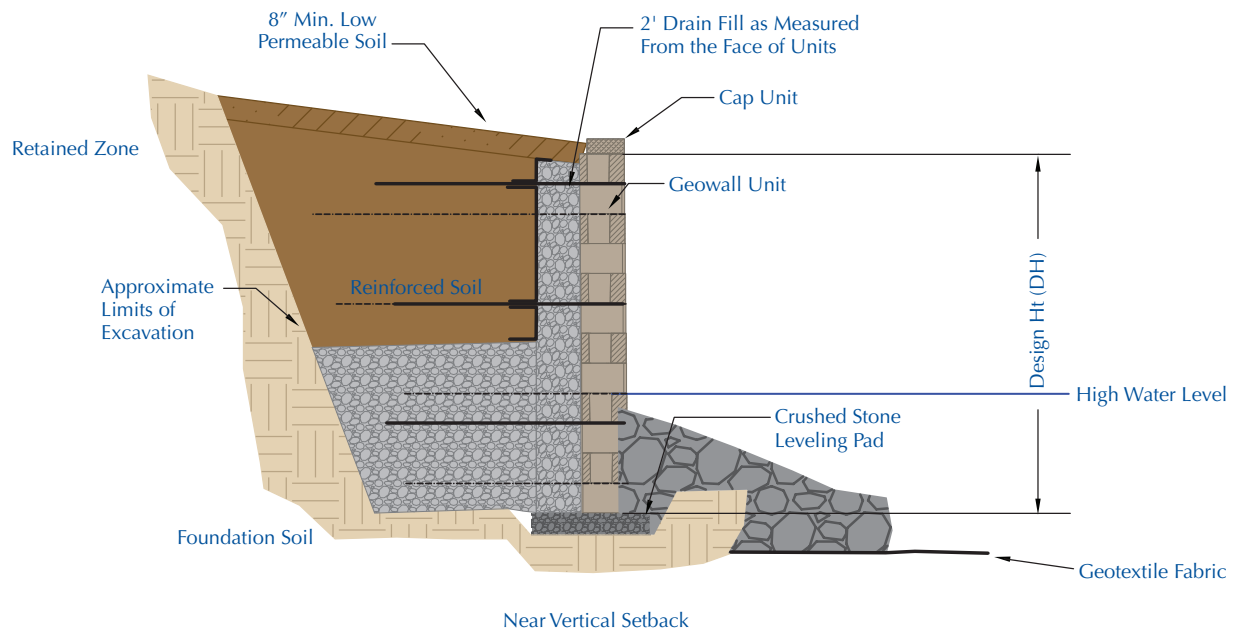

4.7 CURVES – CONVEX WITH GEOGRID

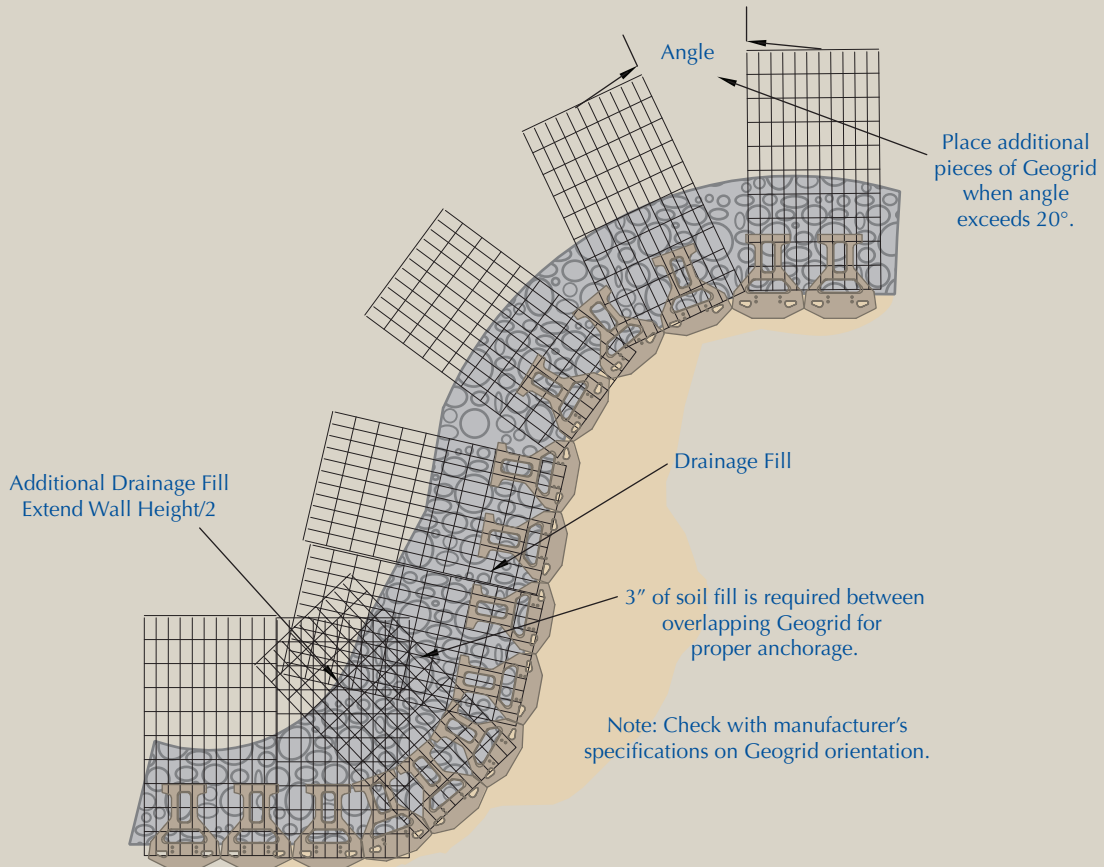

4.8 90 DEGREE CORNER WITH GEOGRID

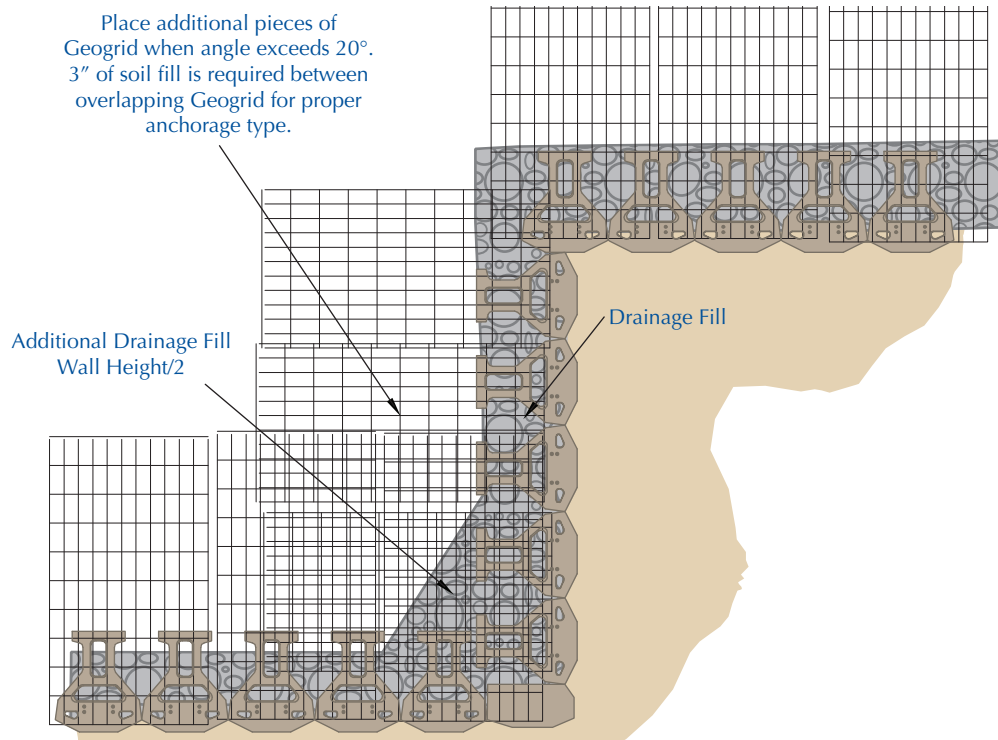

5.1 STANDARDIZED TABLES

Geowall™ Pro designs were done in the near vertical position in accordance with NCMA guidelines and include a seismic coefficient of A=0.2g.

Soil Reinforced Walls: Geowall™ Pro

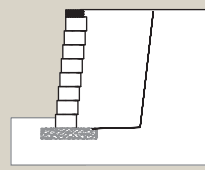

Case A Level, No Surcharge

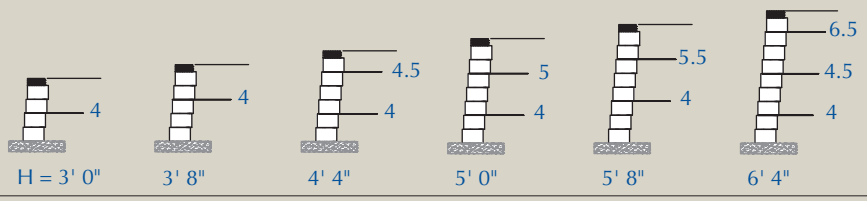

Silty Sand ($\phi \geq 30^\circ$)

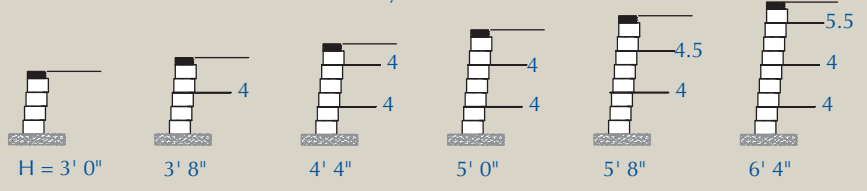

Sand Gravel ($\phi \geq 34^\circ$)

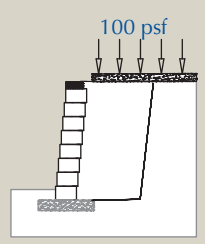

Case B Level, 100 psf Surcharge

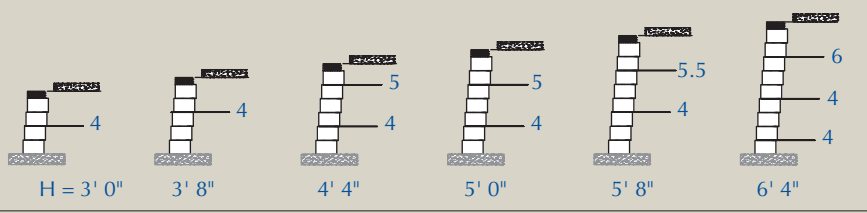

Silty Sand ($\phi \geq 30^\circ$)

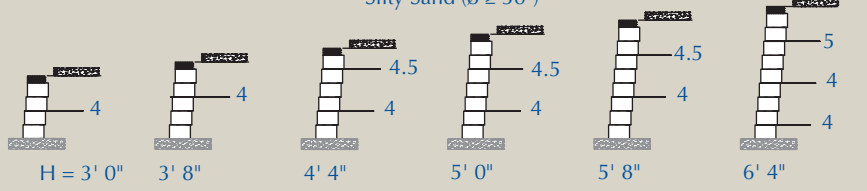

Sand Gravel ($\phi \geq 34^\circ$)

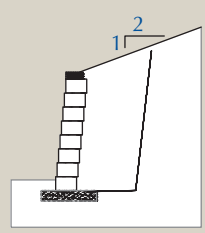

Case C Sloping, No Surcharge

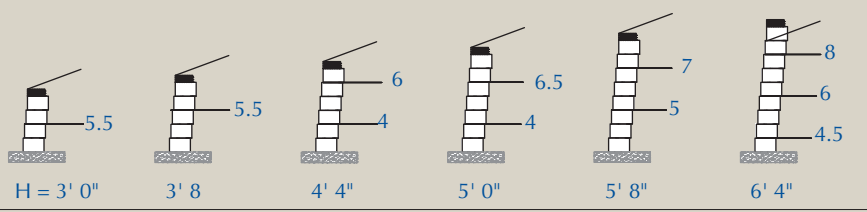

Silty Sand ($\phi \geq 30^\circ$)

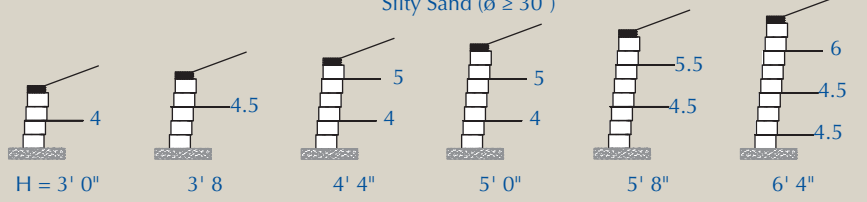

Sand Gravel ($\phi \geq 34^\circ$)

5.1 STANDARDIZED TABLES

Geowall™ Max designs were done in the near vertical position in accordance with NCMA guidelines and include a seismic coefficient of $A=0.2g$.
Soil Reinforced Walls: Geowall™ Max

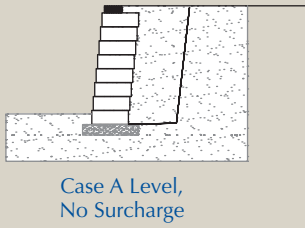

Height (H)	3' 8"	4' 4"	5' 0"	5' 8"	6' 4"
Silty Sand ($\phi \geq 30^\circ$)	4	4	4	4.5	4.5
Sand Gravel ($\phi \geq 34^\circ$)	4	4	4	4	4

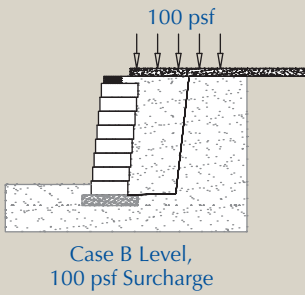

Height (H)	3' 8"	4' 4"	5' 0"	5' 8"	6' 4"
Silty Sand ($\phi \geq 30^\circ$)	5	5.5	6	6.5	7
Sand Gravel ($\phi \geq 34^\circ$)	5	5	5	5.5	6

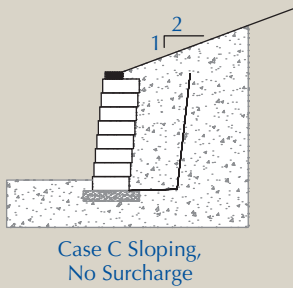

Height (H)	3' 8"	4' 4"	5' 0"	5' 8"	6' 4"
Silty Sand ($\phi \geq 30^\circ$)	5.5	6.5	7	7.5	8
Sand Gravel ($\phi \geq 34^\circ$)	5.5	5.5	6	7	7

Visit Us Online

For more information about Basalite paving stones, retaining walls, accessories, patterns or installation instructions, visit us online at basalite.com.

Offered by:



1300 East Franklin Road
Meridian, ID 83642
208-888-4050

ALBERTA • BRITISH COLUMBIA • CALIFORNIA • COLORADO • IDAHO • NEVADA • OREGON • WASHINGTON

www.basalite.com



©2015 Basalite® Concrete Products, LLC. All trademarks ® are registered trademarks.
The U.S. Green Building Council Member logo is a trademark owned by the U.S. Green Building Council and is used by permission.