

Standardized Engineering

For 3 to 6 foot GEOWALL™ Max Retaining Walls



GEOWALL™ designs were done in accordance with NCMA guidelines. Seismic loading was not included in this Standardized Engineering Packet.

GEOWALL™ MAX UNIT

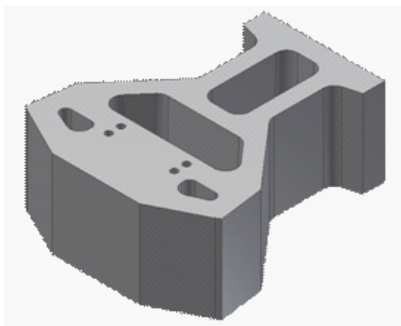

Basalite Concrete Products, LLC

Tel: 800-350-5886 (California)

Table of Contents

Disclaimer.....	2
Introduction.....	3
Wall Materials.....	3
Soil Reinforcement.....	3
Standardized Engineering.....	4
Recommended Use.....	4
Detailed Discussion on Use.....	4
Gravity Wall Tables.....	7
Soil Reinforced Walls: GEOWALL™ Max.....	8

Disclaimer

THE INFORMATION PRESENTED IN THIS TECHNICAL NOTE IS BASED ON THE FOLLOWING ASSUMPTIONS:

- SOIL CONDITIONS AT THE SITE ARE equal TO OR STRONGER THAN THE SOIL CONDITIONS REFERENCED IN THIS STANDARDIZED ENGINEERING DESIGN; AND
- GEOWALL™ RETAINING WALL CONSTRUCTION IS IN ACCORDANCE WITH INDUSTRY STANDARDS AND RECOMMENDATIONS FROM THE SUPPLIERS. PLEASE REFER TO THE NATIONAL CONCRETE MASONRY ASSOCIATION (NCMA) DESIGN MANUAL (3RD EDITION) FOR DESIGN RECOMMENDATIONS, INSTALLATION INSTRUCTIONS AND QUALITY ASSURANCE GUIDELINES FOR SRW CONSTRUCTION NOT CONTAINED IN THIS TECH NOTE.

THE INFORMATION PRESENTED IN THIS TECHNICAL NOTE, INCLUDING TECHNICAL AND ENGINEERING DATA, FIGURES, TABLES, DRAWINGS AND PROCEDURES IS PRESENTED FOR GENERAL INFORMATION ONLY. WHILE EVERY EFFORT HAS BEEN MADE TO ENSURE ITS ACCURACY, THIS INFORMATION SHOULD NOT BE USED OR RELIED UPON FOR ANY SPECIFIC APPLICATION WITHOUT THE INDEPENDENT PROFESSIONAL REVIEW AND VERIFICATION OF ITS ACCURACY, SUITABILITY, AND APPLICABILITY FOR YOUR SPECIFIC PROJECT. ANYONE USING THIS MATERIAL ASSUMES ANY AND ALL LIABILITY, OBLIGATIONS AND/OR CONSEQUENCES RESULTING FROM SUCH USE. BASALITE® CONCRETE PRODUCTS, LLC, DOES NOT INTEND, AND HEREBY DISCLAIMS, ANY AND ALL EXPRESS, IMPLIED OR STATUTORY WARRANTIES, INCLUDING, BUT NOT LIMITED TO, ANY WARRANTY OF MERCHANTABILITY, ANY WARRANTY OF FITNESS FOR A PARTICULAR PURPOSE, ANY IMPLIED WARRANTIES OTHERWISE ARISING FROM COURSE OF DEALING OR USAGE OF TRADE, OR FREEDOM FROM INFRINGEMENT OF ANY PATENT, TRADEMARK, OR COPYRIGHT IN REGARD TO THE INFORMATION OR PRODUCTS CONTAINED OR REFERRED TO HEREIN. NOTHING CONTAINED HEREIN SHALL BE AS GRANTING A LICENSE, EXPRESS OR IMPLIED, UNDER ANY PATENTS, TRADEMARKS, COPYRIGHTS OR OTHER INTELLECTUAL PROPERTY.

BASALITE® CONCRETE PRODUCTS, LLC, DOES NOT INTEND, AND HEREBY DISCLAIMS, ANY AND ALL REPRESENTATION OR WARRANTY, EXPRESSED OR IMPLIED, THAT ANY, OR A PARTICULAR, WALL CONSTRUCTION MAY OR MAY NOT REQUIRE ONE OR MORE BUILDING PERMITS, OR THE SERVICES OF AN ENGINEER.

ALL THE INFORMATION CONTAINED IN THE FOLLOWING PAGES OF THE TECHNICAL NOTE IS GOVERNED AND LIMITED BY THE FOREGOING.

Introduction

This technical note is written specifically for the Basalite GEOWALL™ retaining wall system. Each unit has a different geometry, weight, and characteristics that require specific design considerations in the analyses. Geogrid reinforcement used with these systems has been tested with each unit and the design parameters are used in the analyses.

The purpose of **Standardized Engineering** is to provide working parameters for the design and construction of small GEOWALL™ retaining walls that are in conformance with industry standards and with current ICC building codes for the 3 to 6 foot height range. Large retaining walls, special loading conditions, nearby structures such as pool or buildings, or complex geometries require specific engineering analysis.

It is the user's responsibility to choose and make sure the design and soil parameters are properly verified:

1. Selection of the proper soils is critical to proper design performance.
2. Construction methods must be followed per industry standards and ICC building codes.
3. Surcharge loading and slope geometry are critical to proper wall performance.

Wall Materials

Wall units covered by Standardized Engineering are the pinned structural units, the GEOWALL™ Max units. Each unit receives two (2) pins supplied by Basalite.

GEOWALL™ MAX UNIT

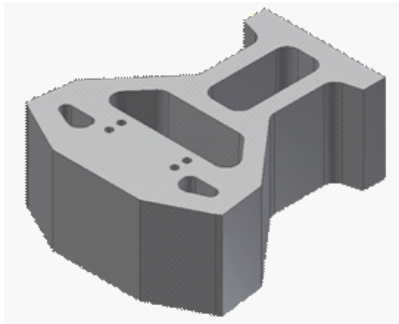

Size:	8" (h) x 18" (w) x 21" (d)
Weight:	92 lbs*
Face Area	1.0 sq. ft.
Delivery:	30 units per pallet

Soil Reinforcement

Soil reinforcements used in the **Standardized Engineering** are as follows:

Stratagrid SG150 by Strata Systems, Inc.	
Long Term Design Strength (LTDS)	1000 lbs/ft
Working Design Strength (Tal)	600 lbs/ft
Miragrid 2XT	
Long Term Design Strength (LTDS)	1046 lbs/ft
Working Design Strength (Tal)	633 lbs/ft
Synteen SF20	
Long Term Design Strength (LTDS)	1269 lbs/ft
Working Design Strength (Tal)	769 lbs/ft

Strata Systems, T.C. Mirafi, and Synteen will provide manufacturer's certification and test data verifying design and performance properties on request.

Standardized Engineering

Standardized Engineering is a set of design charts and recommendations for design and construction of low height retaining walls using the GEOWALL™ retaining wall units. The International Code Council (ICC) recommends building permits for walls greater than 4 feet (ICC 105.2.4) in height. The use of Standardized Engineering does not remove the requirement for a building permit; however it provides the user and building code officials with engineering designs for walls that conform to published industry standards and building code requirements.

Note that this technical note is not a replacement for proper engineering and professionals should be engaged if there is any question to the applicability of these recommendations.

Recommended Use

The following outline gives recommendations on the use of Standardized Engineering:

1. Based on the local building officials and local building codes, determine if Standardized Engineering can be used for wall construction.
2. Determine if building permits are required for wall construction.
3. Determine total wall height including proposed embedment.
4. Determine loading conditions from slopes and surcharges.
5. Determine the type of soils that will be used within 10 feet behind the wall.
6. Determine if gravity walls are applicable or if geogrid reinforcement is required.
7. Determine the proper design section from this document based on items 3 to 6 above.

Detailed Discussion on Use

1. Based on the local building officials and local building codes, determine if Standardized Engineering can be used for wall construction.

Standardized Engineering can be used when acceptable to the local building officials and when wall height, surcharge loading and soil types are consistent with this document.

Standardized Engineering should NOT be used when any of the following conditions apply:

- Total wall height is in excess of 6 feet plus cap unit from leveling pad.
- Backslope above the wall is steeper than 2 horizontal to 1 vertical
- Special surcharge loading conditions exist such as traffic loading or buildings
- Toe slope in front of the wall
- Terraced or multiple tier wall applications spaced closer than two times the height of the lower wall.
- Unusual groundwater conditions

2. Determine if building permits are required for wall construction.

The ICC suggests building permits for any retaining walls 4 feet tall or higher (ICC 105.2.4). However the application of this suggestion is based on the local building code and the local building code officials. Some local building codes may be more restrictive requiring building permits and engineering design for any height retaining wall structure.

If permits are required, submit the **Standardized Engineering** along with any other site drawings, surveys, manufacturer literature, etc. that may be required by the building department. When required, secure a Professional Engineer's stamp on proposed construction documents such as the **Standardized Engineering** document.

Note: Unit weights may vary due to aggregate sources and manufacturing. Check with manufacturer for unit weights if required.

3. Determine total wall height including proposed embedment.

The total height of the structure is important to assess the earth pressure and soil loading on the retaining wall. As the height of the structure increases, the loading increases as a function of the height and the calculated factor of safety against failure decreases.

The total height of the structure is the vertical distance from the top of the leveling pad to the top of grade behind the wall. Minimum embedment of the wall units is 8 inches below grade. Minimum embedment provided a depth to where the wall will not get undermined from work in front of the wall or site drainage.

4. Determine loading conditions from slopes and surcharges.

There are many combinations of slopes, geometry changes and surcharges that may affect the performance of the retaining wall. In this Standardized Engineering the choices have been simplified to:

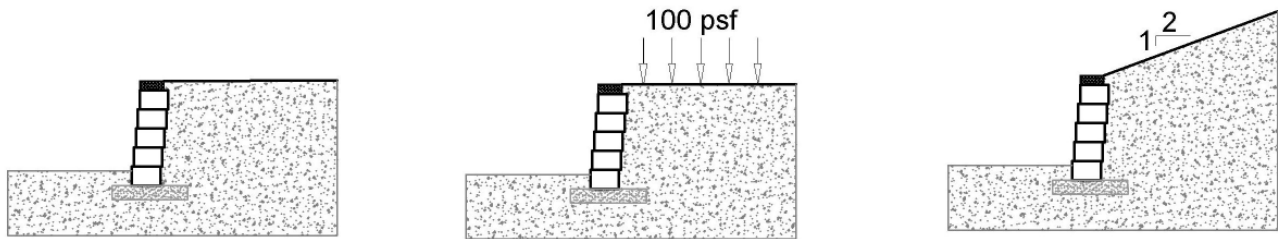

Case A
Level Backfill, No Surcharge

Case B Patio or Driveway
Level Backfill, 100 psf Surcharge

Case C
Sloping Backfill (2V: 1H)

5. Determine the type of soils that will be used.

Standardized Engineering only permits “good” soils and does not consider fine grained soils (clays and silts) as good backfill material. Clays and silts may cause settlement, drainage and other poor performance characteristics of the wall.

Soils best suited for retaining wall construction are granular soils such as sands and gravel. The ICC code (Table 1610.1) defines these soils as:

- | | | |
|---|----|-------------------|
| • Well-graded, clean gravels; gravel-sand mixes | GW | $\phi > 34^\circ$ |
| • Poorly graded clean gravels; gravel-sand mixes | GP | $\phi > 34^\circ$ |
| • Silty gravels, poorly graded gravel-sand mixes | GM | $\phi > 30^\circ$ |
| • Clayey gravels, poorly graded gravel-and-clay mixes | GC | $\phi > 30^\circ$ |
| • Well-graded, clean sands; gravelly sand mixes | SW | $\phi > 34^\circ$ |
| • Poorly graded clean sands; sand-gravel mixes | SP | $\phi > 30^\circ$ |
| • Silty sands, poorly graded sand-silt mixes | SM | $\phi > 30^\circ$ |

6. Determine if gravity walls are applicable or if geogrid reinforcement is required.

Gravity walls are preferred in many shorter wall locations because of the amount of excavation and area required for reinforcement behind the wall face. Tables on the following pages show allowable gravity heights for GEOWALL™ Max units.

Surcharge loads above the walls, slopes above the walls and poorer grade soils all reduce the allowable gravity heights of the retaining walls. When gravity walls are not suitable based on calculations or values in the table, geogrid reinforcement is used to effectively widen the base width of the retaining wall.

7. Determine the proper design section from this document based on items 3 to 6 above.

The following pages provide typical design sections for GEOWALL™ units selected, the type of soil conditions and the loading condition.

8. Verify proper licensing for construction of wall with state licensing board.

It is always recommended that the contractor be properly licensed and carry the appropriate insurance.

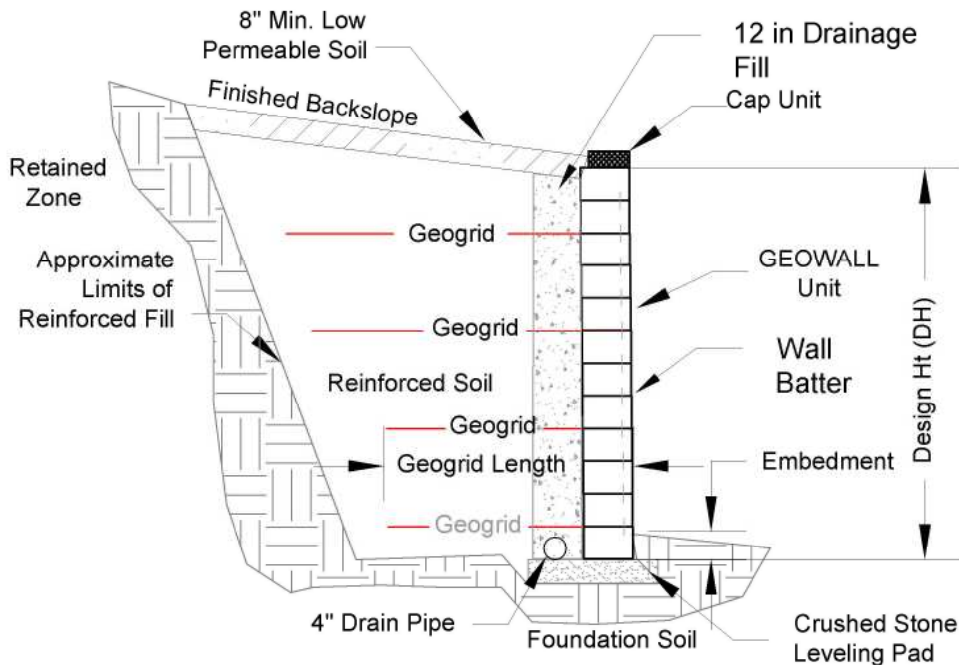

GEOWALL™ Unit:	Max pinned units
GEOWALL™ Cap	Cap units – 4” or 8” in height. Cap units are secured to the top wall block with adhesive per manufacturer’s recommendations.
Setback/Batter	Wall setback is determined by the multiple pin locations in each unit as required by the geometry and design. Typical wall batters are: <ul style="list-style-type: none"> • 1° Near vertical • 8° 1 inch setback
Embedment	Embedment is provided to provide depth so the wall does not get undermined by erosion in front of the wall and to provide depth for bearing capacity. Minimum values are 6 inches or 5 percent of the height, whichever is greater. Removed and replace poor foundation soils as necessary.
Wall Height	Height from top of leveling pad to top grade supported by the wall.
Leveling Pad	Crushed stone (6 in thick) or lean concrete (4 in thick) to provide a firm surface to place the base unit.

- Drain Pipe 4 in perforated pipe placed behind the bottom block to provide additional drainage. Pipe should discharge to a drainage swale or storm drainage system.
- Unit Drainage Fill Drainage fill is a clean, free-draining crushed stone that is placed within the front 2 feet of the retaining wall (12 inches behind the Max)
- Reinforced Fill Structural fill placed and compacted in the zone behind the facing units with geogrid reinforcing included at the lengths and elevations shown in the design.
- Geogrid Geogrid reinforcing is polyester reinforcing (Stratagrid SG150, Mirafi 2XT, Synten SF20) placed over the pins and pulled taut over the reinforced fill to provide internal reinforcing to the soil mass. Place on level surface.
- Finished Slope Finished backslope shall be a low permeable layer of soil to prevent surface runoff from filtering into the wall backfill.

Gravity Wall Tables

GEO WALL™ MAX UNIT

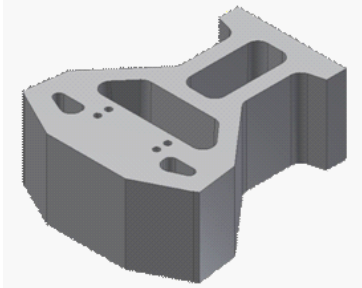

GEO WALL™ Max designs

GEO WALL™ designs were done in accordance with NCMA guidelines. Seismic coefficient was not included.

Soil Type	A	B	C
Silty Sand ($\phi = 30^\circ$)	4' 4"	3' 0"	N/A
Sand / Gravel ($\phi = 34^\circ$)	5'-0"	3' 8"	2' 4"
Max Total Height from Leveling Pad			

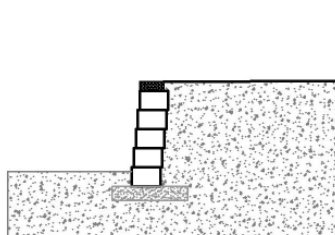

Case A
Level Backfill, No Surcharge

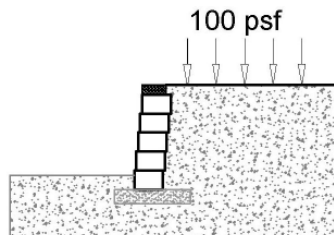

Case B Patio or Driveway
Level Backfill, 100 psf Surcharge

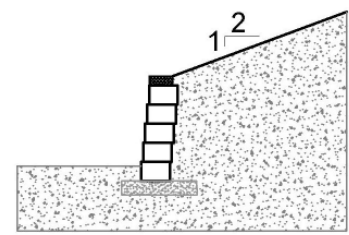

Case C
Sloping Backfill (2V: 1H)

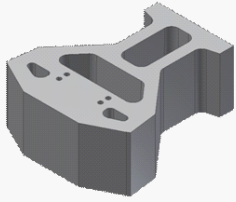

Soil Reinforced Walls: GEOWALL™ Max

GEOWALL™ Max designs were done in accordance with NCMA guidelines.

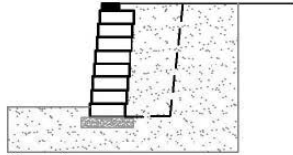

Case A
Level, No Surcharge

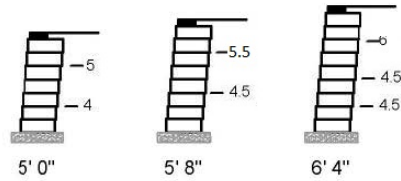

Silty Sand ($\phi \geq 30^\circ$)

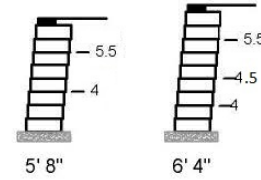

Sand Gravel ($\phi \geq 34^\circ$)

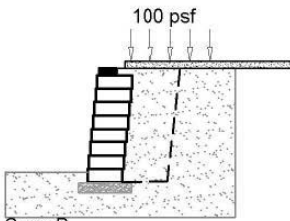

Case B
Level, 100 psf Surcharge

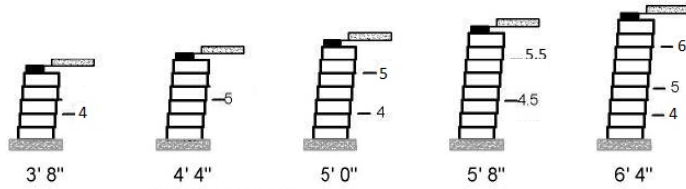

Silty Sand ($\phi \geq 30^\circ$)

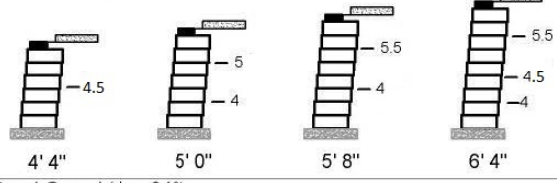

Sand Gravel ($\phi \geq 34^\circ$)

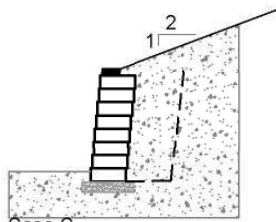

Case C
Sloping, No Surcharge

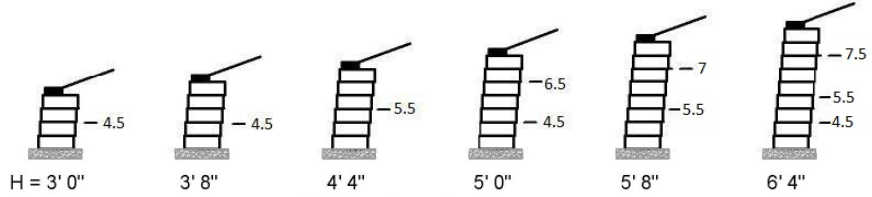

Silty Sand ($\phi \geq 30^\circ$)

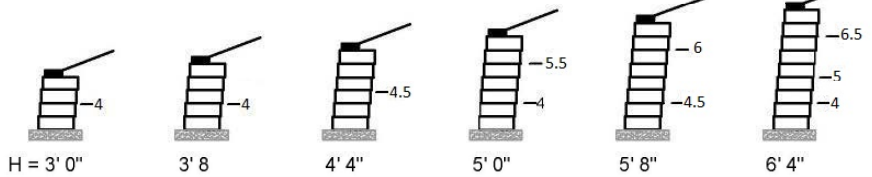

Sand Gravel ($\phi \geq 34^\circ$)